



**TROCARS,
SUCTION TUBES
PROBES**



Cap Only

Fig. 1 07-102-01 1.7 mm Ø
Fig. 2 07-103-02 3 mm Ø
Fig. 3 07-104-03 4.5 mm Ø
Fig. 4 07-104-04 6 mm Ø

UNIVERSAL Abdominal Trocar Set
07-101-00
(Handle with 4 needles) 14 cm
Fig. 1.7 mm Ø to 6 mm Ø
07-105-05
Only Handle

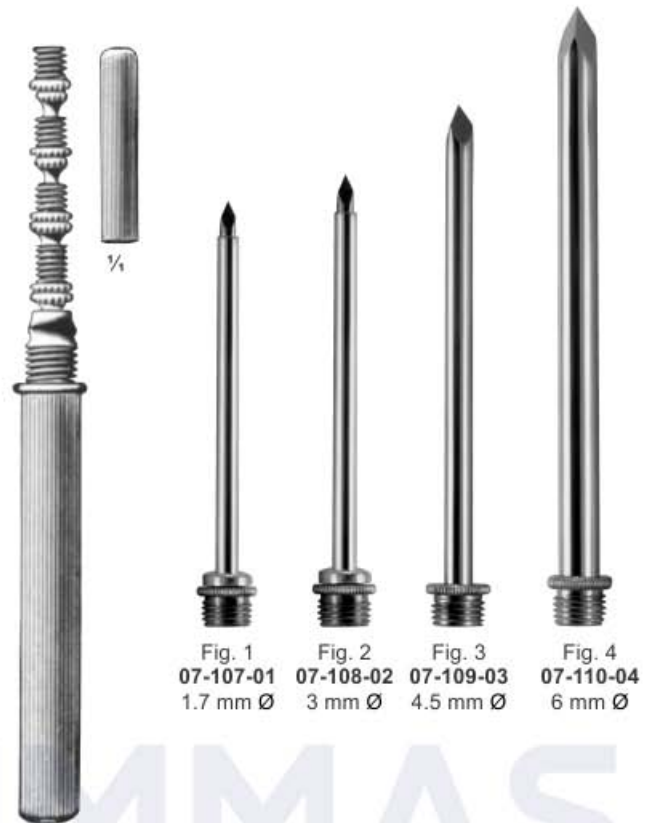

1/4

Fig. 1 07-107-01 1.7 mm Ø
Fig. 2 07-108-02 3 mm Ø
Fig. 3 07-109-03 4.5 mm Ø
Fig. 4 07-110-04 6 mm Ø

UNIVERSAL Abdominal Trocar Set
07-106-00
(Handle with 4 needles) 14 cm
Fig. 1.7 mm Ø to 6 mm Ø
07-111-05
Only Handle



LUER, Trocar
07-112-00
Luer Lock Adapter



Uckermann, Trocar
07-113-13
13 cm



Sinus, Trocar
17 cm



07-114-01
3.5 mm Ø



07-115-02
5.0 mm Ø



07-116-03
5.0 mm Ø

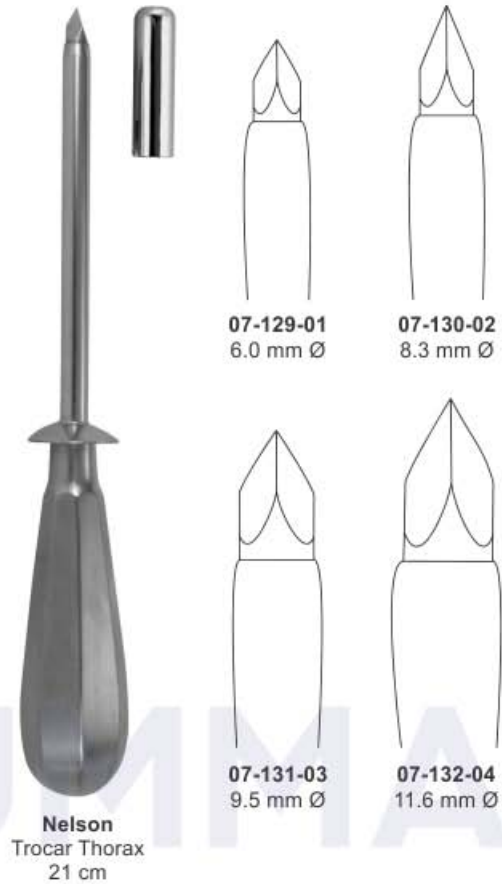
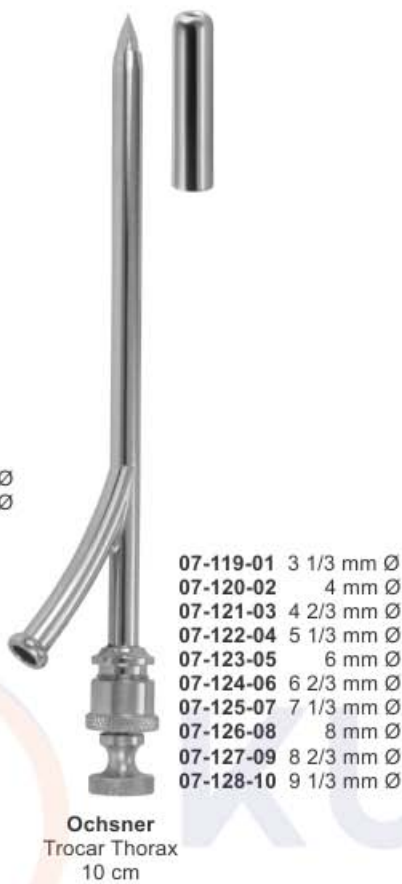

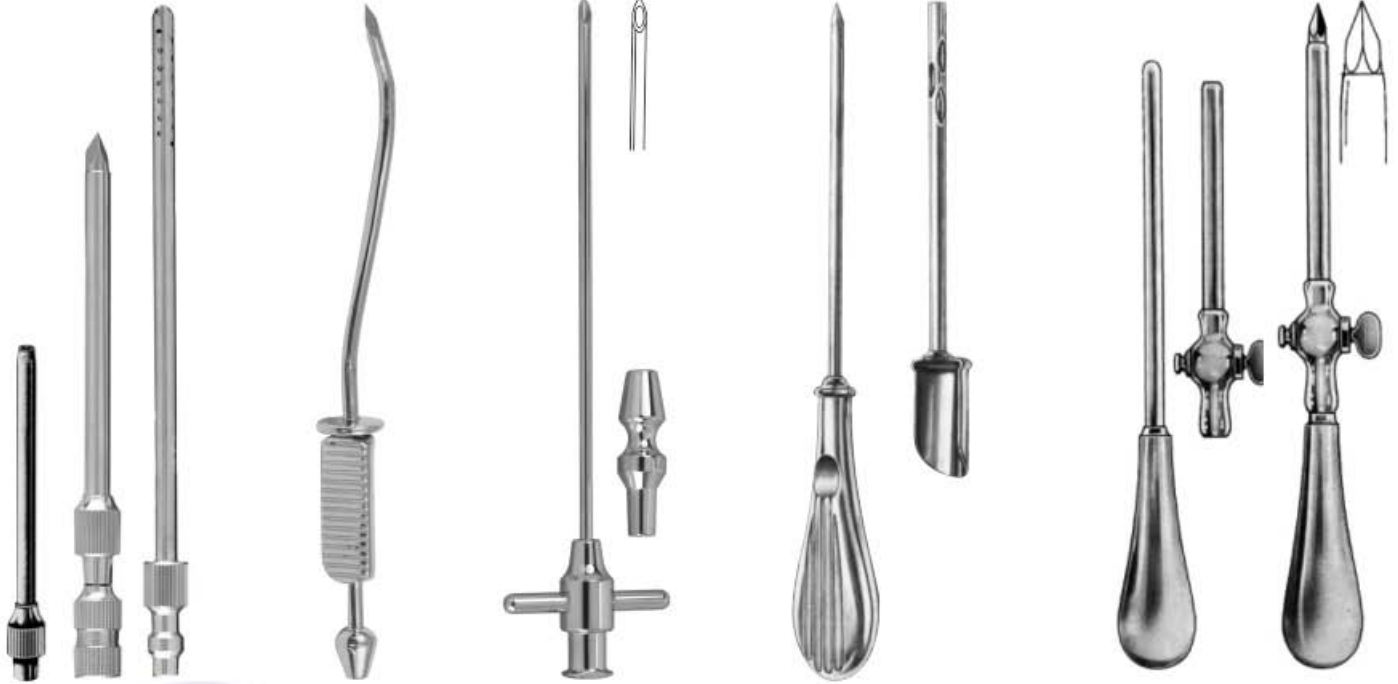

Duke Trocar
07-140-11
11 cm.
5.5 mm Ø

Douglas Trocar
07-141-12
12cm
3 mm

Trocar
07-142-11
11 cm

Birch Trocar
07-143-18
18 cm
4.5 mm

Buelau, Trocar
07-144-24 8 mm
24 cm



NELSON
Innen-Ø Außen-Ø
Inside diam. Outside diam.
07-145-30 2,2mm 3,0mm
07-146-40 3,0mm 4,0mm
07-147-50 4,0mm 5,0mm
07-148-60 5,0mm 6,0mm
07-149-65 5,5mm 6,5mm
for hydrocele and abdominal
puncture

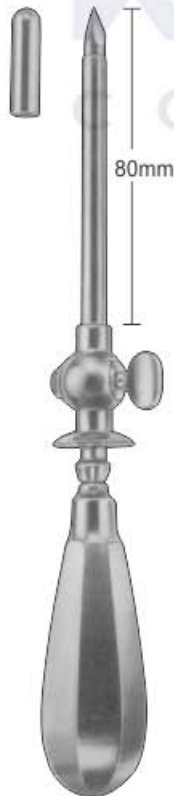

ROBERTS
Inside diam. Outside diam.
07-150-50 4,0mm 5,0mm
07-151-60 5,0mm 6,0mm
07-152-65 5,5mm 6,5mm
for abdominal puncture,
with stop-cock



GRAETE
Inside diam. Outside diam.
07-153-30 2,2mm 3,0mm
07-154-40 3,0mm 4,0mm
07-155-50 4,0mm 5,0mm
07-156-60 5,0mm 6,0mm
for abdominal puncture, with stop
-cock and lateral drain



BILLROTH
Inside diam. Outside diam.
07-157-60 5,0mm 6,0mm
Ovarian trocar

SUCTION TUBES

Saugrohre	Tubos de aspiracion
Canules d'aspiration	Tubi per aspirazione

Pool Suction Tube

22 cm, Straight

07-158-06 Ø 6mm (18 French) Charr.

07-159-10 Ø10mm (30 French) Charr.



Pool Suction Tube

22 cm, Curved

07-160-06 Ø6mm (18 French) Charr.

07-161-08 Ø8mm (23 French) Charr.



Ø 1.5 mm

Yankauer
07-162-28
28cm

Yankauer
07-163-29
29cm

DeBakey
07-164-28
28cm

Andrews-Pynchon
07-165-24 24 cm

Coupland
Suction Tube
07-166-00



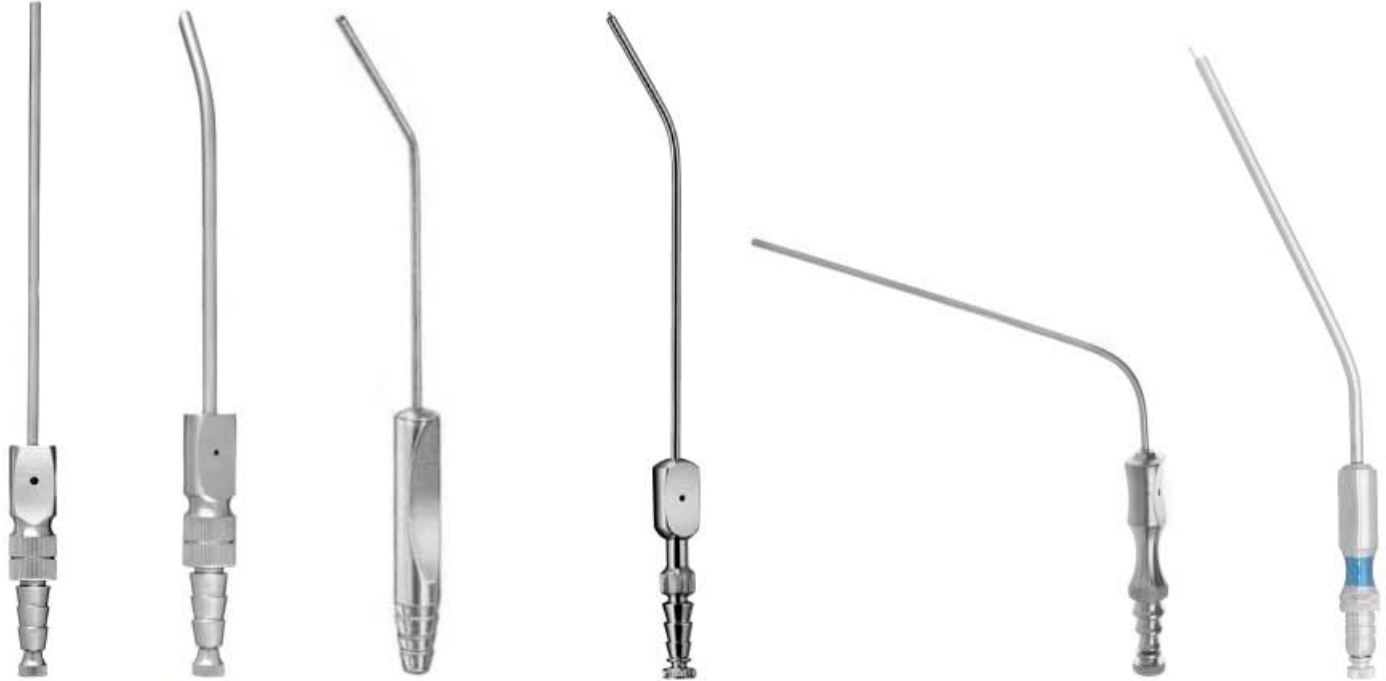

Adson
suction tubes
07-175-15
4 mm Ø
15cm

Adson
suction tubes
21 cm
07-176-01
4 mm Ø 12 Charr./Fr.
07-177-02
5 mm Ø 15 Charr./Fr.

Wullstein Suction
Tube Complete
07-178-01

Plester Suction Tubes 19.5cm
Suction Tubes, with finger cut-off
and stylet. Luer attachment, angled
07-179-06 2.0 mm Ø 6 Charr./Fr.
07-180-07 2.3 mm Ø 7 Charr./Fr.
07-181-08 2.5 mm Ø 8 Charr./Fr.
07-182-09 3.0 mm Ø 9 Charr./Fr.
07-183-10 3.3 mm Ø 10 Charr./Fr.
07-184-11 3.5 mm Ø 11 Charr./Fr.
07-185-12 4.5 mm Ø 12 Charr./Fr.
07-186-15 5.0 mm Ø 15 Charr./Fr.

Fergusson Suction Tubes 18cm
Suction Tubes, with finger cut-off
and stylet. Luer attachment, angled
07-187-06 2.0 mm Ø 6 Charr./Fr.
07-188-07 2.3 mm Ø 7 Charr./Fr.
07-189-08 2.5 mm Ø 8 Charr./Fr.
07-190-09 3.0 mm Ø 9 Charr./Fr.
07-191-10 3.3 mm Ø 10 Charr./Fr.
07-192-11 3.5 mm Ø 11 Charr./Fr.
07-193-12 4.5 mm Ø 12 Charr./Fr.
07-194-15 5.0 mm Ø 15 Charr./Fr.

FRAZIER 30°
suction tubes
07-195-06 6 Fr.
07-196-07 7 Fr.
07-197-08 8 Fr.
07-198-09 9 Fr.
07-199-10 10 Fr.
07-200-11 11 Fr.
07-201-12 12 Fr.
07-202-13 13 Fr.
07-203-15 15 Fr.
18 cm



FRAZIER
suction tubes
07-204-06 6 Fr.
07-205-07 7 Fr.
07-206-08 8 Fr.
07-207-09 9 Fr.
07-208-10 10 Fr.
07-209-11 11 Fr.
07-210-12 12 Fr.
07-211-13 13 Fr.
07-212-15 15 Fr.
19 cm



FRAZIER 30°
suction tubes
07-213-06 6 Fr.
07-214-07 7 Fr.
07-215-08 8 Fr.
07-216-09 9 Fr.
07-217-10 10 Fr.
07-218-11 11 Fr.
07-219-12 12 Fr.
07-220-13 13 Fr.
07-221-15 15 Fr.
18 cm



FRAZIER 45°
suction tubes
07-222-06 6 Fr.
07-223-07 7 Fr.
07-224-08 8 Fr.
07-225-09 9 Fr.
07-226-10 10 Fr.
07-227-11 11 Fr.
07-228-12 12 Fr.
18 cm

Cannula
07-229-06 ○ 6fr
07-230-07 ○ 7fr
07-231-08 ○ 8fr
07-232-09 ○ 9fr
07-233-10 ○ 10fr
07-234-11 ○ 11fr
07-235-12 ○ 12fr
07-236-13 ○ 13fr
07-237-14 ○ 14fr





Luer
07-238-01
Suction Tube
working
length 110 mm



Byrd, Suction Tube
07-239-15 1.5 mm
07-240-25 2.5mm
07-241-35 3.5 mm



Nasal Suction Tubes
07-242-45 Ø 4.5mm
07-243-55 Ø 5.5mm
17.5 cm



**Gorney
Suction Tubes**
07-244-18
18 cm
suction dissector



**Landolt Dissecting
Suction Tubes**
07-245-04 4 mm wide
07-246-05 5 mm wide
20 cm
suction raspatories, sharp,



**Lopez-Reinke
Suction Tubes**
07-247-23
23.5 cm
tonsil dissector with
suction device



Plester Daumenplatt
07-248-06 6 Charr./Fr.
07-249-07 7 Charr./Fr.
07-250-08 8 Charr./Fr.
07-251-09 9 Charr./Fr.
07-252-10 10 Charr./Fr.
07-253-11 11 Charr./Fr.
07-254-12 12 Charr./Fr.
07-255-15 15 Charr./Fr.



Baron suction tubes 7.5 cm
07-256-03 1 mm Ø 3 Charr./Fr.
07-257-05 1 2/3 mm Ø 5 Charr./Fr.
07-258-07 2 1/3 mm Ø 7 Charr./Fr.

Baron suction tubes 10 cm
07-259-03 1 mm Ø 3 Charr./Fr.
07-260-05 1 2/3 mm Ø 5 Charr./Fr.
07-261-07 2 1/3 mm Ø 7 Charr./Fr.

House suction tubes 7.5 cm
07-262-03 1 mm Ø 3 Charr./Fr.
07-263-05 1 2/3 mm Ø 5 Charr./Fr.
07-264-07 2 1/3 mm Ø 7 Charr./Fr.
07-265-08 2 2/3 mm Ø 8 Charr./Fr.
07-266-10 3 1/3 mm Ø 10 Charr./Fr.
07-267-12 4 mm Ø 12 Charr./Fr.
07-268-14 4 2/3 mm Ø 14 Charr./Fr.

House suction tubes 10 cm
07-269-03 1 mm Ø 3 Charr./Fr.
07-270-05 1 2/3 mm Ø 5 Charr./Fr.
07-271-07 2 1/3 mm Ø 7 Charr./Fr.
07-272-08 2 2/3 mm Ø 8 Charr./Fr.
07-273-10 3 1/3 mm Ø 10 Charr./Fr.
07-274-12 4 mm Ø 12 Charr./Fr.
07-275-14 4 2/3 mm Ø 14 Charr./Fr.

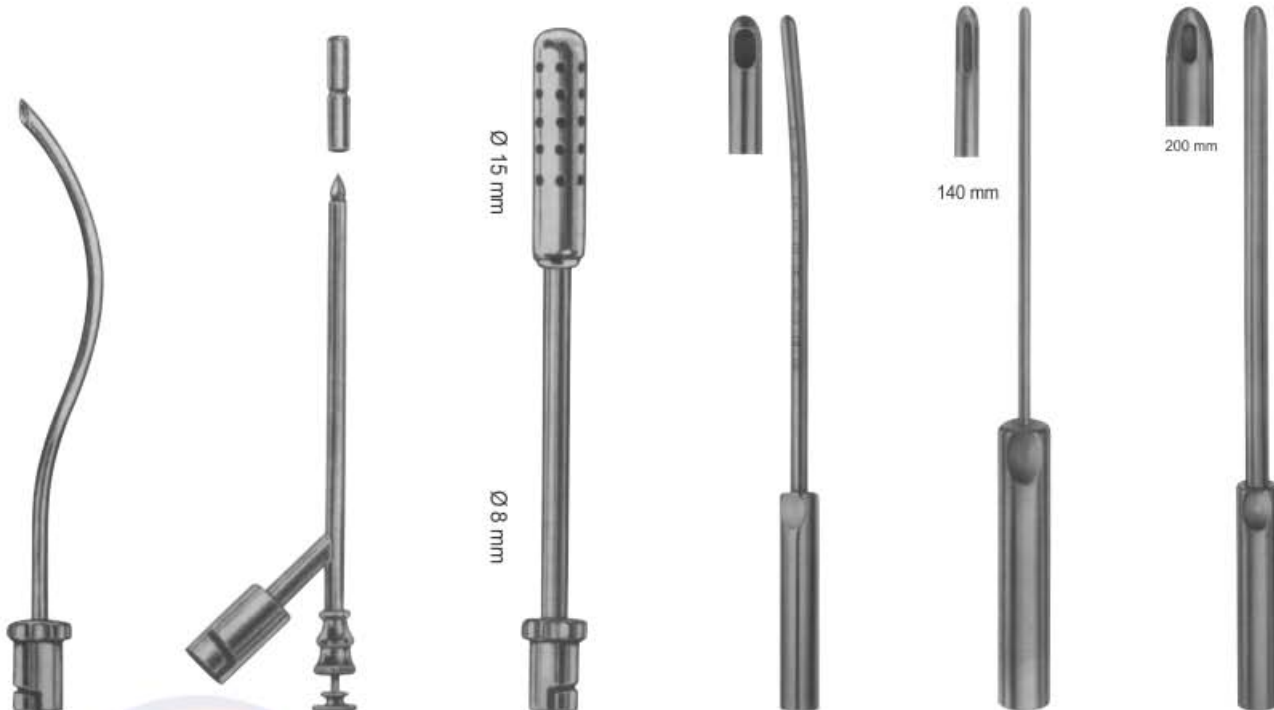

SUCTION TUBES

07-276-17

17 cm

For aspirating fluid from the excretory ducts of large glands and for keeping the operating area clear

SUCTION TUBES

07-277-15

15 cm

For aspirating fluid from the excretory ducts of large glands and for keeping the operating area clear

SUCTION TUBES

07-278-19

19 cm

For aspirating fluid from the excretory ducts of large glands and for keeping the operating area clear

BIEMER

07-279-04 Ø 4 mm

07-280-06 Ø 6 mm

07-281-08 Ø 8 mm

07-282-10 Ø 10 mm

07-283-12 Ø 12 mm

07-284-14 Ø 14 mm

Curettes for aspiration lipectomy, graduated, slightly curved

BIEMER

07-285-04 Ø 4 mm

07-286-06 Ø 6 mm

Curettes for aspiration lipectomy, with three apertures, slightly curved malleable

BIEMER

07-287-08 Ø 8 mm

07-288-10 Ø 10 mm

07-289-12 Ø 12 mm

Curettes for aspiration lipectomy, with three apertures, slightly curved malleable



07-290-23

Suction Tube 23 cm double curved for general surgery

07-291-19

Suction Tube 19 cm double curved for general surgery

07-292-22

Suction Tube 22 cm double curved for general surgery

Trocar

07-293-17

17 cm For puncturing

Hollow Needle

07-294-15 15 cm sharp

Ø 1.75 mm

WULLSTEIN
07-295-16

16 cm
Suction tube, conical, silver, oliver with LUER hub

WULLSTEIN

07-296-01 Ø 1.5 mm

07-297-02 Ø 2.0 mm

16 cm
Suction tube, cylindrical, silver, with stylet with LUER hub

Usable length

YASARGIL suction tube
usable length diam.

07-298-01	13 cm	1.5 mm
07-299-02	15 cm	1.5 mm
07-300-03	18 cm	1.5 mm
07-301-04	22 cm	1.5 mm
07-302-05	13 cm	2.0 mm
07-303-06	15 cm	2.0 mm
07-304-07	18 cm	2.0 mm
07-305-08	22 cm	2.0 mm

YASARGIL suction tube
usable length diam.

07-306-01	13 cm	2.5 mm
07-307-02	15 cm	2.5 mm
07-308-03	18 cm	2.5 mm
07-309-04	22 cm	2.5 mm
07-310-05	13 cm	3.5 mm
07-311-06	15 cm	3.5 mm
07-312-07	18 cm	3.5 mm
07-313-08	22 cm	3.5 mm
07-314-09	18 cm	4.5 mm

Ø 6.5-9 mm
with LUER hub

Landolt
Suction Tube
15 cm diam Ø 3mm

07-315-08	08 mm / curved
07-316-11	11 mm / curved
07-317-15	15 mm / curved

Ø 3.5 mm

Ø 2.0 mm

Suction Tube
07-318-35 35cm
07-319-50 50cm
with rubber tip,
with LUER hub

Ø 9 mm

Suction Tube
07-320-01 Ø 2.0 mm
07-321-02 Ø 2.5 mm
07-322-03 Ø 3.0 mm
25 cm
with finger cut-off
thumb piece 90 to
curved, with luer hub

Ø 6-9 mm

BUIE Suction Tube
07-323-45
45 cm with finger
valve, 15 Fr. (5 mm)

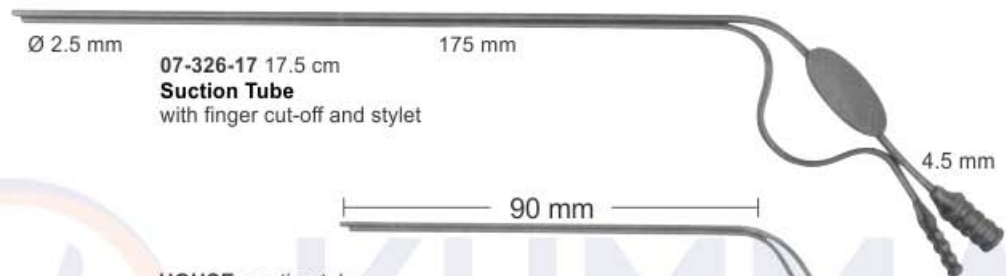
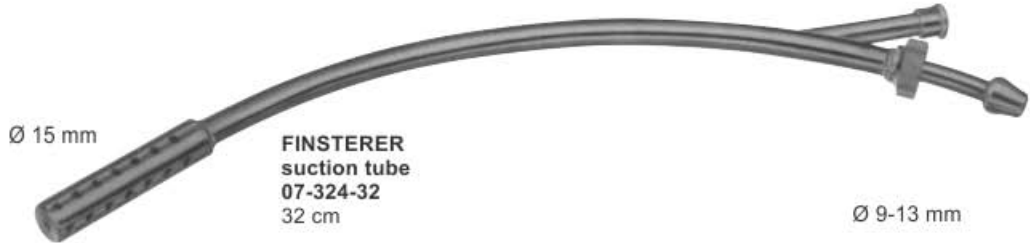

HOUSE, suction tube

	Suction tube diam.	irrigationtube diam.	
07-327-09	0.9 mm	0.7 mm	07-330-07
07-328-12	1.2 mm	0.9 mm	07-331-09
07-329-15	1.5 mm	1.2 mm	07-332-12

with finger cut-off and stylet,
with lure hub

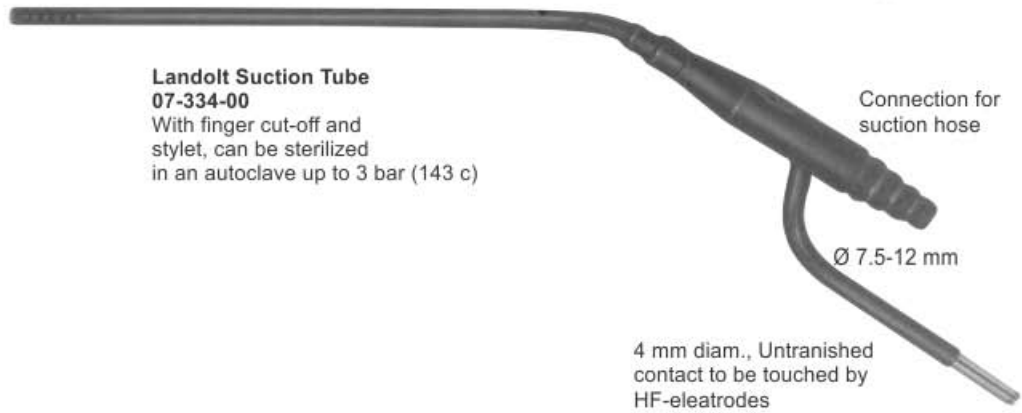

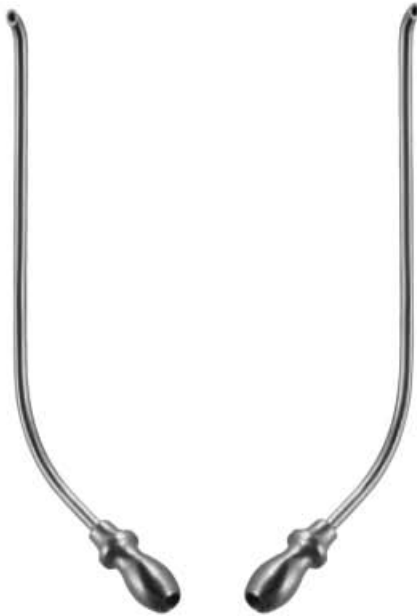

Hartmann, Eustachian Catheters
Fig. 1
07-335-20 2.0 mm Ø
07-336-25 2.5 mm Ø
07-337-30 3.0 mm Ø

Hartmann Eustachian Catheters
Fig. 2
07-338-20 2.0 mm Ø
07-339-25 2.5 mm Ø
07-340-30 3.0 mm Ø



Killian, Eustachian Catheters
07-341-25 16 cm 2.5 mm Ø
07-342-30 16 cm 3.0 mm Ø oval opening

Killian
07-343-15 Ø 1.5mm



Hartmann eustachian catheters
15 cm

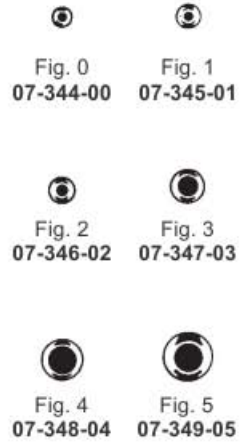

Tröltzsch eustachian catheters
15 cm

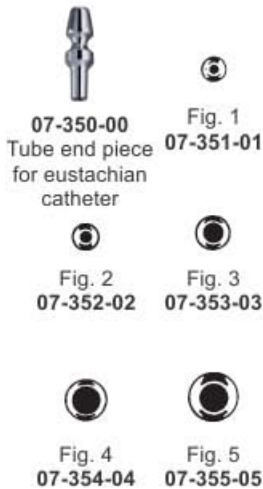

Catheter
16 cm
female catheters

	Charr. (French)
07-356-06	Ø 6
07-357-07	Ø 7
07-358-08	Ø 8
07-359-09	Ø 9
07-360-10	Ø 10
07-361-11	Ø 11
07-362-12	Ø 12
07-363-13	Ø 13
07-364-14	Ø 14
07-365-15	Ø 15
07-366-16	Ø 16
07-367-18	Ø 18
07-368-20	Ø 20

Female catheters, metal
16cm

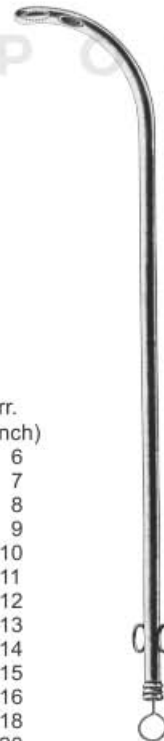

Catheters
Male Metal
29 cm

	Charr (French)
07-369-08	Ø 8
07-370-10	Ø 10
07-371-12	Ø 12
07-372-14	Ø 14
07-373-16	Ø 16
07-374-18	Ø 18
07-375-20	Ø 20



Bell Erishipake
07-376-65
6.5cm



Eicken Suction & Irrigation Cannula
 07-377-25 2.5 mm Ø
 07-378-30 3.0 mm Ø
 Slightly curved



Eicken Suction & Irrigation Cannula
 07-379-25 2.5 mm Ø
 07-380-30 3.0 mm Ø
 Strongly curved



Tonsil Needle Suction & Irrigation Cannula
 07-381-08 0.8 mm Ø
 Straight



Tonsil Needle Suction & Irrigation Cannula
 07-382-08 0.8 mm Ø
 Curved



Septum Needle Suction & Irrigation Cannula
 07-383-08 0.8 mm Ø
 bayonet



Septum Needle Suction & Irrigation Cannula
 07-384-08 0.8 mm Ø
 angled on flat



Luer-Lock Suction & Irrigation Cannula
 07-385-30 3.0 mm Ø



Luer-Lock Suction & Irrigation Cannula
 07-386-25 2.5 mm Ø



Fisch Suction & Irrigation Cannula
 07-387-40 4.0 mm Ø



Ø 5mm



DE Bakey with finger cut-off and stylet
 07-388-16
 16cm



Ø 5mm



DE Bakey with finger cut-off and stylet
 07-389-27
 27cm



Ring Type Suction Tube
 07-390-01



Zöllner, suction tube
07-391-07 Ø 0.7 mm
complete with 1 slip-on
cannula, Ø 0.7 mm



Iowa, suction tube
07-392-07 Ø 0.7 mm
16 cm



Magill, suction tube
24.5 cm
07-393-30 Ø 3.0 mm
07-394-35 Ø 3.5 mm
07-395-40 Ø 4.0 mm



Rosen, suction tube
X=80 mm
07-396-07 Ø 0.7 mm
07-397-09 Ø 0.9 mm
07-398-12 Ø 1.2 mm



Rosen, suction tube
X=65 mm
07-399-07 Ø 0.7 mm
07-400-09 Ø 0.9 mm
07-401-12 Ø 1.2 mm



Suction Tube Guide Needle
19.5 cm
07-402-08 Ø 2.2/3 mm 8 Fr.
07-403-10 Ø 3.1/3 mm 10 Fr.
07-404-12 Ø 4 mm 12 Fr.
07-405-14 Ø 4 2/3 mm 14 Fr.
07-406-16 Ø 5 1/3 mm 16 Fr.
07-407-18 Ø 6 mm 18 Fr.



Suction Tube Guide Needle
19.5 cm
07-408-06 Ø 2 mm 6 Fr.
07-409-08 Ø 2.2/3 mm 8 Fr.
07-410-10 Ø 3 1/3 mm 10 Fr.
07-411-12 Ø 4 mm 12 Fr.
07-412-14 Ø 4 2/3 mm 14 Fr.
07-413-16 Ø 5 1/3 mm 16 Fr.
07-414-18 Ø 6 1/3 mm 18 Fr.



Suction Tube Guide Needle
Lancet Tip 19.5 cm
07-415-08 Ø 2.2/3 mm 8 Fr.
07-416-10 Ø 3.1/3 mm 10 Fr.
07-417-12 Ø 4 mm 12 Fr.
07-418-14 Ø 4 2/3 mm 14 Fr.
07-419-16 Ø 5 1/3 mm 16 Fr.
07-420-18 Ø 6 mm 18 Fr.



Quinke, Biopsy Needle
07-421-01 1.20 x 76.0 mm Ø
07-422-02 1.20 x 89.0 mm Ø
07-423-03 1.00 x 76.0 mm Ø
07-424-04 1.00 x 89.0 mm Ø
07-425-05 0.70 x 76.0 mm Ø
07-426-06 0.70 x 50.0 mm Ø
07-427-07 0.70 x 89.0 mm Ø



Tuohy, Biopsy Needle
07-428-01 1.20 x 76.0 mm Ø
07-429-02 1.40 x 76.0 mm Ø
07-430-03 1.60 x 76.0 mm Ø



Bier, Biopsy Needle
07-431-01 1.20 x 80.0 mm Ø



**Klima - Rosegger
Biopsy Needle**
07-432-01 1.80 x 35.0 mm Ø



Frazier
07-433-01
 12cm / 3mm

KUMMAS
 CORPORATION



Verres, Biopsy Needle
07-434-01 2.00 x 100 mm Ø
07-435-02 2.00 x 120 mm Ø
07-436-03 2.00 x 150 mm Ø



Menghini, Biopsy Needle
07-437-01 1.00 x 35.0 mm Ø
07-438-02 1.00 x 70.0 mm Ø
07-439-03 1.20 x 35.0 mm Ø
07-440-04 1.20 x 70.0 mm Ø
07-441-05 1.20 x 100.0 mm Ø
07-442-06 1.20 x 35.0 mm Ø
07-443-07 1.40 x 70.0 mm Ø
07-444-08 1.40 x 100.0 mm Ø
07-445-09 1.20 x 35.0 mm Ø
07-446-10 1.60 x 70.0 mm Ø
07-447-11 1.80 x 100.0 mm Ø



Menghini, Biopsy Needle
07-448-12 1.40 x 168.0 mm Ø
07-449-13 1.80 x 168.0 mm Ø



Biopsy Needle
07-450-01 2.00 x 105 mm Ø
07-451-02 2.00 x 130 mm Ø
 for kidney biopsy, incl.
 Guide needle
 Outer diameter



Biopsy Needle
07-452-01 1.50 x 155 mm Ø
07-453-02 1.50 x 180 mm Ø
 for kidney biopsy, incl.
 Guide needle
 Inner diameter



Franklin-Silverman
 Biopsy Needle
07-454-01 2.00 x 105 mm Ø
07-455-02 2.50 x 145 mm Ø
 for liver and kidney biopsy
 without barb



Franklin-Silverman
 Biopsy Needle
07-458-01 1.50 x 155 mm Ø
07-459-02 1.50 x 180 mm Ø
 for liver and kidney biopsy
 barber

Franklin-Silverman
 Biopsy Needle
07-456-01 2.00 x 105 mm Ø
07-457-02 2.50 x 145 mm Ø
 Biopsy needle, only

Franklin-Silverman
 Biopsy Needle
07-460-01 1.50 x 155 mm Ø
07-461-02 1.50 x 180 mm Ø
 Biopsy needle, only

ISLAM BONE MARROW BIOPSY NEEDLE SET

- 07-462-00 ISLAM ASPIRATION NEEDLE SET**
without Side Holes, 2.55mm outer Diameter, 70mm Shaft Length
- 07-463-00 ISLAM ASPIRATION NEEDLE SET**
without Side Holes, 2.55mm outer Diameter, 100mm Shaft Length
- 07-464-00 ISLAM STANDAED BONE MARROW BIOPSY NEEDLE SET**
2.1mm Biopsy Diameter, 3.25mm Outer Diameter, 70mm Shaft Length
- 07-465-00 ISLAM STANDAED BONE MARROW BIOPSY NEEDLE SET**
2.1mm Biopsy Diameter, 3.25mm Outer Diameter, 100mm Shaft Length
- 07-466-00 ISLAM STANDAED BONE MARROW BIOPSY NEEDLE SET**
2.1mm Biopsy Diameter, 3.25mm Outer Diameter, 125mm Shaft Length
- 07-467-00 ISLAM PEDIATRIC ASPIRATION NEEDLE SET**
Without Side Holes, 2.00mm outer Diameter, 50mm Shaft Length
- 07-468-00 ISLAM PEDIATRIC ASPIRATION NEEDLE SET**
Without Side Holes, 2.00mm outer Diameter, 70mm Shaft Length
- 07-469-00 ISLAM PEDIATRIC BONE MARROW BIOPSY NEEDLE SET**
1.37mm Biopsy Diameter, 2.38 outer Diameter, 50mm Shaft Length
- 07-470-00 ISLAM PEDIATRIC BONE MARROW BIOPSY NEEDLE SET**
1.37mm Biopsy Diameter, 2.38 outer Diameter, 70mm Shaft Length
- 07-471-00 ISLAM PEDIATRIC BONE MARROW BIOPSY NEEDLE SET**
1.37mm Biopsy Diameter, 2.38 outer Diameter, 90mm Shaft Length



PROBES

Sonden | Sondas
Sondes | Sonde

Double Ended Probe

1.0 mm Ø
07-472-11 11.5 cm
07-473-13 13 cm
07-474-14 14.5 cm
07-475-16 16 cm
07-476-18 18 cm
07-477-20 20 cm
07-478-25 25 cm

Double Ended Probe

1.5 mm Ø
07-479-11 11.5 cm
07-480-13 13 cm
07-481-14 14.5 cm
07-482-16 16 cm
07-483-18 18 cm
07-484-20 20 cm
07-485-25 25 cm

Double Ended Probe

2.0 mm Ø
07-486-11 11.5 cm
07-487-13 13 cm
07-488-14 14.5 cm
07-489-16 16 cm
07-490-18 18 cm
07-491-20 20 cm
07-492-25 25 cm

Probe With Eye

2.0 mm Ø
07-493-11 11.5 cm
07-494-13 13 cm
07-495-14 14.5 cm
07-496-16 16 cm
07-497-18 18 cm
07-498-20 20 cm
07-499-25 25 cm
 with eyelet

Probe

2.0 mm Ø
07-500-11 11.5 cm
07-501-13 13 cm
07-502-14 14.5 cm
07-503-16 16 cm
 myrtle-shaped



Fein
cotton applicator
07-504-28 28 cm



Pelteson
cotton applicator
07-505-23 23 cm



Bowman Lacrimal Probes
Double Ended, Sterling Silver
07-506-01 Fig. 000-0000
07-507-02 Fig. 00-0
07-508-03 Fig. 1-2
07-509-04 Fig. 3-4
07-510-05 Fig. 5-6
07-511-06 Fig. 7-8



William Lacrimal Probes
Double Ended, Sterling Silver
07-512-01 Fig. 000-0000
07-513-02 Fig. 00-0
07-514-03 Fig. 1-2
07-515-04 Fig. 3-4
07-516-05 Fig. 5-6
07-517-06 Fig. 7-8



Stacke
07-518-10
10 cm



Rocket Hook
07-519-00



Killian
07-520-16
16.5 cm



Probe
07-521-16
16.5 cm



Seiffert
07-522-11 11 cm
07-523-13 13 cm
07-524-14 14 cm
07-525-16 16 cm
07-526-18 18 cm



**Jobson Home
Probe**
07-527-12 12.5cm
07-528-14 14.5cm
07-529-18 18cm



BARR Fistula Probe
07-530-20
with 20.3 cm sterling shaft,
eye at tip, 29.2 cm overall



BARR Crypt Hook
07-531-25
25.4 cm short and
long hook ends



**Butterfly Grooved
Director With Tongue Tie
Plain End**
07-532-11 11.5 cm
07-533-13 13 cm
07-534-14 14.5 cm
07-535-16 16 cm
07-536-18 18 cm
07-537-20 20 cm



**Butterfly Grooved
Director With Tongue Tie
Plain End**
07-538-11 11.5 cm
07-539-13 13 cm
07-540-14 14.5 cm
07-541-16 16 cm
07-542-18 18 cm
07-543-20 20 cm

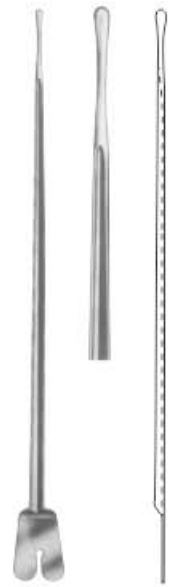
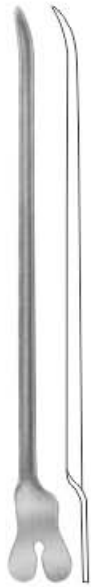

Directors
07-544-13 13cm
07-545-14 14.5cm
07-546-16 16cm
Larry Probe
and Grooved
Director,
17.8 cm

Doyen
07-547-14
14.5cm

Nelaton
07-548-16
16cm

**Director Probe
End**
07-549-14 14cm
Director with tip
Diam. of tip
3.3 mm

Brodie
07-550-20 20cm
Director with
tip Diam. of
tip 3.5 mm

KUMMAS
CORPORATION

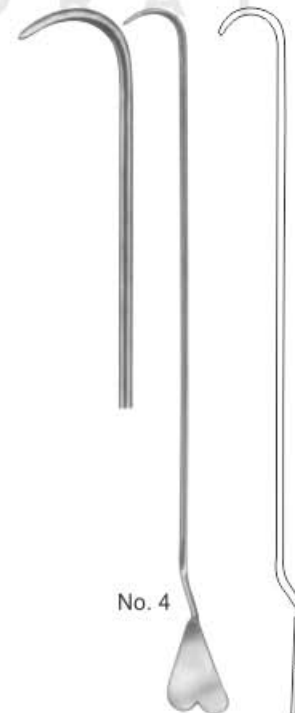
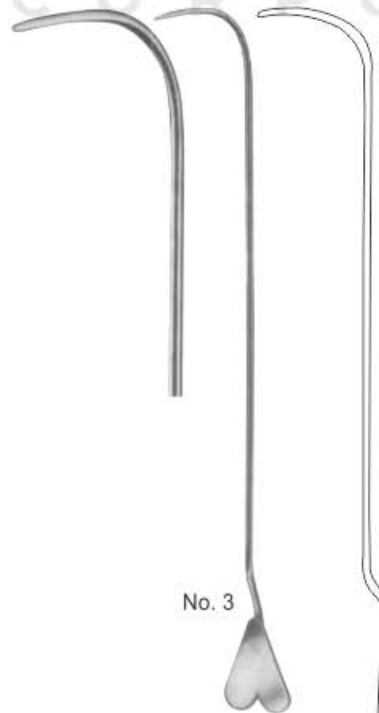
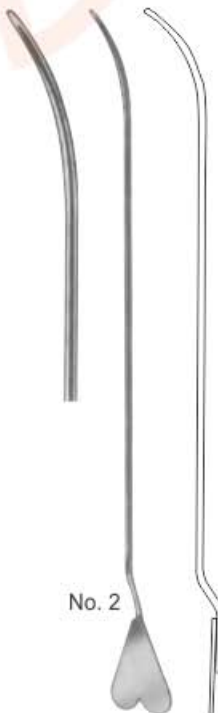

No. 1

No. 2

No. 3

No. 4

Lockhart-Mummery
07-551-01 No. 1 Straight
07-552-02 No. 2 45° Curved
07-553-03 No. 3 90° Curved
07-554-04 No. 4 retrograde curved
Fistula probes

**Director with wire
loop, malleable**
07-555-19 19 cm